



Ming Feng Lighting Co.,Ltd

Tel:+86-769-2203-6051 Fax: +86-769-2203-6052

Add: Wen Tang Administration, East City,Dongguan,Guangdong Province,China.

MF-P240 LED Parking Light Data Sheet

FEATURES

Light Source: 150LM/W **SAMSUNG 351B Chip / CREE XTE Chip** options, efficiency achieves 130LM/W.

Driver:Taiwan **Meanwell LED Driver**, Wide AC90-305V, PF>0.98,low THD<9%.

Waterproof Grade: **IP65**

Beam Angle: **90°, 120°, 90*120°, 85*135°**

Functions: **Dimmable, Photocell** available.

Warranty: Five years

Material: Powder coated die casting aluminum, High standard corrosion resistant finishing and UV resistant can be optional if required.

Certificated: **CE, TUV, ROHS, FCC, DLC**

Body color : Grey/ Black/Silver

SPECIFICATIONS

Part No.	MF-P240
THD:	<15%
CCT:	3000K,4000K and 5000K
CRI:	Ra80+
Beam angle:	90°, 120°, 90*120°, 85*135°
Input Voltage:	AC90-305V 50/60Hz
Power Factor:	>0.98
LED Power:	240W
System Consumption:	248W
LED Driver:	Meanwell driver
LED Chip:	SAMSUNG,Cree Options
Total Lumens	31200lm
Efficacy	130+ lm/w
Mounting:	pole/wall mount as option
IP Rating	IP65
Working Condition:	Temperature: -40°C~60°C Humidity: 10%~95%
Lifetime:	100,000 hrs
Weight:	N.W:9.5Kg G.W:11.0kg
Product Size:	670(L)x343(W)x176(H)MM
Packing:	828(L)X 395(W)X 115(H) MM/1PCS

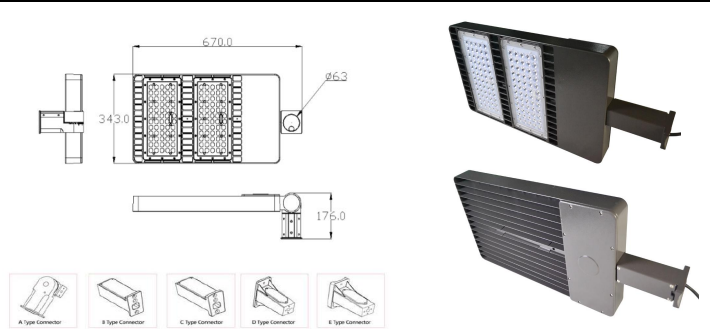

BENEFITS

Installation 6 different kinds of bracket available for pole, wall...etc installation.

Excellent Heat Sink Design: Hollow out heat sink design make the lamp lighter and good heat dissipation.

Power Supply design: Built-in Meanwell driver, meet IEC standard.

Application: Industrial, freeway, country road, landscape area

Light Distribution Curve

